

Year 5

PROMPT sheet

5/1 Place value in numbers to 1million

The position of the digit gives its size

Millions	Hundred thousands	Ten thousands	thousands	hundreds	tens	units
1	2	3	4	5	6	7

Example

The value of the digit '1' is 1 000 000

The value of the digit '2' is 200 000

The value of the digit '3' is 30 000

The value of the digit '4' is 4000

5/2 Round numbers to nearest 10, 100, 1000, 10000, 100000

Example 1- Round 342 679 to the nearest 10 000

- Step 1 - Find the 'round-off digit' - 4
- Step 2 - Look one digit to the right of 4 - 2

5 or more? NO - leave 'round off digit' unchanged
- Replace following digits with zeros

ANSWER - 340 000

Example 2- Round 453 679 to the nearest 100 000

- Step 1 - Find the 'round-off digit' - 4
- Step 2 - Look one digit to the right - 5

5 or more? YES - add one to 'round off digit'
- Replace following digits with zeros

ANSWER - 500 000

5/3 Negative numbers

A number line is very useful for negative numbers.

- The number line below shows:

$$4 - 7 = -3$$

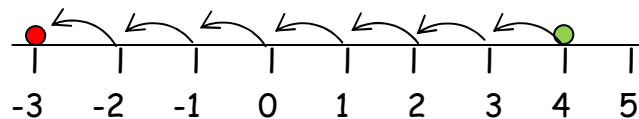

- The number line below shows:

$$-2 + 6 = 4$$

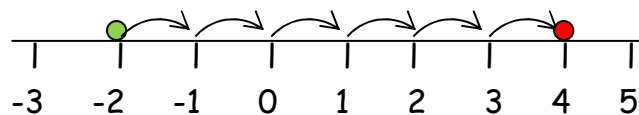

5/4 Roman Numerals

The seven main symbols



I = 1

V = 5

X = 10

L = 50

C = 100

D = 500

M = 1000

Other useful ones include:

IV = 4

IX = 9

XL = 40

XC = 90

5/5 Written methods for addition

- Line up the digits in the correct columns
- Start from RIGHT to LEFT

e.g. 48 + 284 + 9

H T U

4 8

2 8 4

1 2 9 +

3 4 1

5/5 Written methods for subtraction

- Line up the digits in the correct columns
- Start from RIGHT to LEFT

e.g. 645 - 427

H T U

6 ~~4~~ 15

4 2 7 -

2 1 8

5/6 Mental methods for addition

- **Start from LEFT to RIGHT**

Example 1 - think of:

$$45 + 32 \text{ as } 45 + 30 + 2$$

- But in your head say:

45 75 77

Example 2 - think of:

$$1236 + 415 \text{ as } 1236 + 400 + 10 + 5$$

- But in your head say:

1236 1636 1646 1651

5/6 Mental methods for subtraction

Example 1 - think of:

$$56 - 32 \text{ as } 56 - 30 - 2$$

- But in your head say:

56 26 24

Example 2 - think of:

$$1236 - 415 \text{ as } 1236 - 400 - 10 - 5$$

- But in your head say:

1236 836 826 821

5/7 Multi-step problems

Based upon 5/6.

Words associated with addition:



Words associated with subtraction:

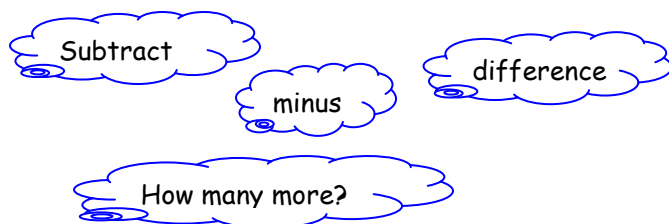

5/8 Multiples & factors

- **FACTORS** are what divides exactly into a number

e.g. Factors of 12 are:

1	12
2	6
3	4

Factors of 18 are:

1	18
2	9
3	6

The common factors of 12 & 18 are: 1, 2, 3, 6,
The Highest Common Factor is: 6

- **MULTIPLES** are the times table answers

e.g. Multiples of 5 are:

5	10	15	20	25
---	----	----	----	----	-------

Multiples of 4 are:

4	8	12	16	20
---	---	----	----	----	-------

The Lowest Common Multiple of 5 and 4 is: 20

5/9 Prime numbers

Prime numbers have only TWO factors

The factors of 12 are:

1, 2, 3, 4, 6, 12



12 is NOT prime
It is composite

Factors of 7 are:

1, 7



7 IS prime

Prime numbers to 20

1	2	3	4	5
6	7	8	9	10
11	12	13	14	15
16	17	18	19	20

The number '1' is NOT prime

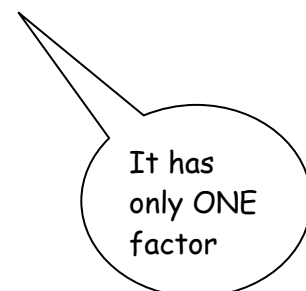

5/10 Multiplication using a formal method

- By a **ONE-DIGIT** number

e.g. 3561×7 COLUMN METHOD

$$\begin{array}{r} 3561 \\ \underline{7 \times} \\ 24927 \\ \text{34} \end{array}$$

e.g. 3561×7 GRID METHOD

	3000	500	60	7
7	21000	3500	420	49

$$21000 + 3500 + 420 + 49 = 24927$$

- By a **TWO-DIGIT** number

e.g. 152×34 COLUMN METHOD

$$\begin{array}{r} 152 \\ \underline{34 \times} \\ 608 \quad (\times 4) \\ 4560 \quad (\times 30) \\ \hline \mathbf{5168} \end{array}$$

e.g. 152×34 GRID METHOD

	100	50	2
30	3000	1500	60
4	400	200	8

$$152 \times 34 = 3400 + 1700 + 68 = \mathbf{5168}$$

5/10 Division using a formal method

- By a **ONE-DIGIT** number

e.g. $9138 \div 6$
$$\begin{array}{r} 1526 \\ 6 \overline{)9138} \end{array}$$

- By a **TWO-DIGIT** number

e.g. $4928 \div 32$ SAME METHOD

(Except write down some of your tables down first)

$$\begin{array}{r} 32 \\ 64 \\ 96 \\ 128 \\ 160 \\ \hline 0154 \\ 32 \overline{)4928} \end{array}$$

$$4928 \div 32 = \mathbf{154}$$

e.g. $4928 \div 32$ ALTERNATE METHOD

- Divide
- Multiply
- Subtract
- Bring down - Make a new number
- Divide ...

$$\begin{array}{r} 0154 \\ 32 \overline{)4928} \\ \underline{-32} \quad \downarrow \\ 172 \\ \underline{-160} \quad \downarrow \\ 128 \\ \underline{-128} \\ 000 \end{array}$$

$$4928 \div 32 = \mathbf{154}$$

5/11 Multiply & divide by 10, 100, 1000

- **By moving the decimal point**

To **multiply** by 10 move the dp ONE place RIGHT

e.g. $13 \overset{\curvearrowright}{} \times 10 = 130$

$3.4 \overset{\curvearrowright}{} \times 10 = 34$

To **divide** by 10 move the dp ONE place LEFT

e.g. $13 \overset{\curvearrowleft}{} \div 10 = 1.3$

$3.4 \overset{\curvearrowleft}{} \div 10 = 0.34$

- **By moving the digits**

To multiply by 10 move the digits ONE place LEFT



e.g. 3.52×10
 $= 35.2$

To multiply or divide by 100 move TWO places

To multiply or divide by 1000 move THREE places

5/12 Square & Cube numbers

Square numbers

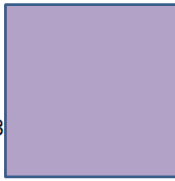
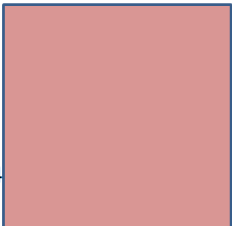
1	2	3	4
			
1x1	2x2	3x3	4x4
1 ²	2 ²	3 ²	4 ²
1	4	9	16

Cube numbers

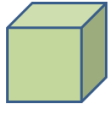
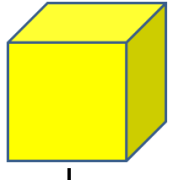
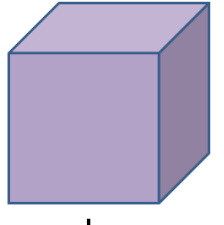
			
1x1x1	2x2x2	3x3x3	4x4x4
1 ³	2 ³	3 ³	4 ³
1	8	27	64

5/13 Fractions

- To compare fractions
- the denominators must be the same

$\frac{2}{3}$ and $\frac{5}{6}$ \longrightarrow 😬

$\frac{4}{6}$ and $\frac{5}{6}$ \longrightarrow 😄

SO $\frac{5}{6}$ is bigger than $\frac{2}{3}$

- To add and subtract fractions

When the denominators are the same

$\frac{5}{8} + \frac{1}{8} = \frac{6}{8}$

Do not add
the denominators

$\frac{5}{8} - \frac{1}{8} = \frac{4}{8}$

Do not subtract
the denominators

5/13 To add subtract fractions (cont)

When the denominators are different

$$\frac{3}{8} + \frac{1}{4} \quad \begin{matrix} \times 2 \\ \times 2 \end{matrix}$$

$$\frac{3}{8} + \frac{2}{8} = \frac{5}{8}$$

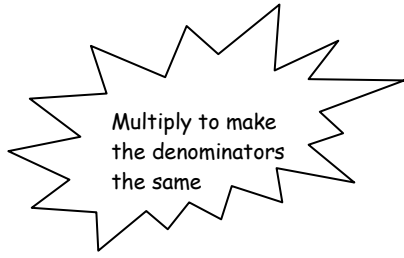

- A mixed number can be changed back into an improper fraction

$$1\frac{1}{2} = \frac{3}{2}$$

$$2\frac{3}{4} = \frac{11}{4}$$

5/14 Equivalent fractions

These fractions are the same but can be drawn and written in different ways

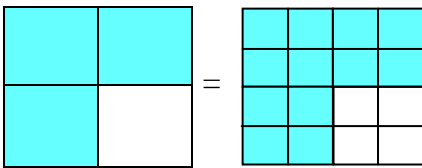

$$\frac{3}{4} = \frac{12}{16}$$

$$\frac{3}{4} \times 4 = \frac{12}{16} \times 4$$

Fractions can also be divided to make the fraction look simpler - this is called CANCELLING or LOWEST FORM

$$\frac{12}{16} \div 4 = \frac{3}{4} \div 4$$

5/15 Mixed & improper fractions

- An improper fraction is top heavy & can be changed into a mixed number

$\frac{3}{2}$ can be shown in a diagram

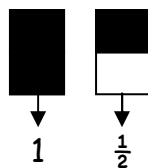

$$\frac{3}{2} = 1\frac{1}{2}$$

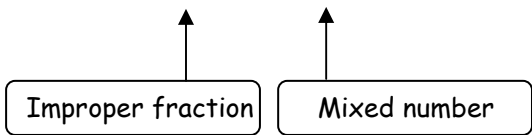

5/16 Multiply fractions

Multiply is the same as repeated addition

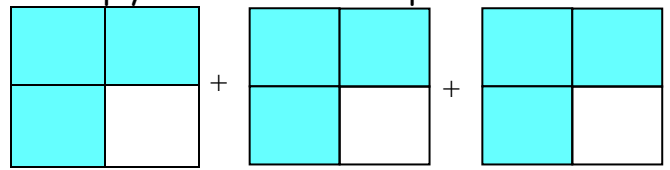

$$\frac{3}{4} + \frac{3}{4} + \frac{3}{4}$$

$$\frac{3}{4} \times 3 = \frac{3}{4} + \frac{3}{4} + \frac{3}{4} = \frac{9}{4} = 2\frac{1}{4}$$

OR

$$\frac{3}{4} \times \frac{3}{1} = \frac{9}{4} = 2\frac{1}{4}$$

5/19 Decimal & Percentage equivalents

Learn

Fraction	Decimal	Percentage
$\frac{1}{2}$	0.5	50%
$\frac{1}{4}$	0.25	25%
$\frac{1}{5}$	0.2	20%
$\frac{1}{10}$	0.1	10%
$\frac{1}{100}$	0.01	1%

Some fractions have to be changed to be 'out of 100'

$$\frac{11}{25} \stackrel{(\times 4)}{=} = \frac{44}{100} = 0.44 = 44\%$$

5/20 Convert metric measure

• Length

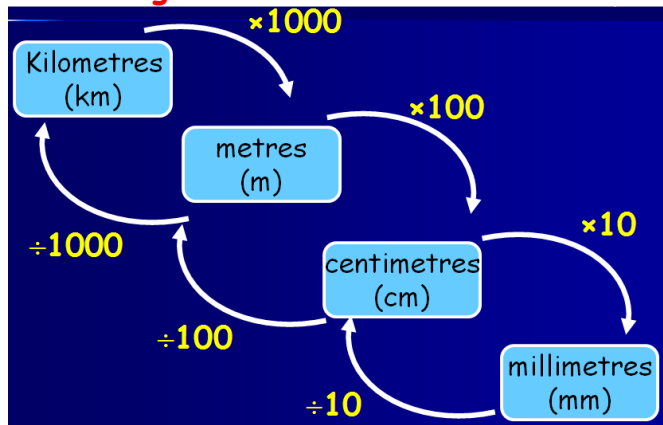

• Mass or weight

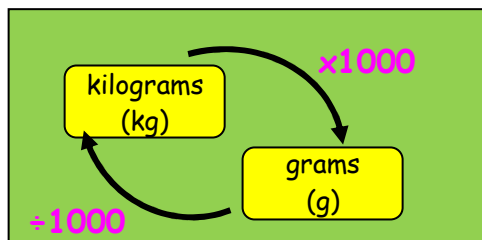

• Capacity or volume

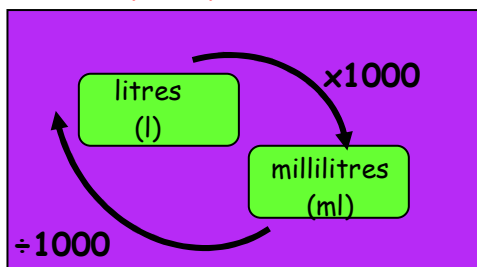

5/20 Imperial measure

- 1 inch is about 2.5cm

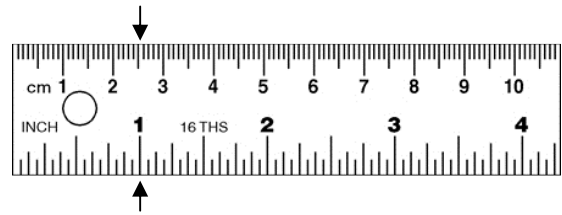

- 1km = 1.6 miles or 5miles = 8km

- 1kg is about 2.2pounds



- A litres of water's a pint and three quarters



- A gallon is about 4.5 litres



5/21 Area & Perimeter

• Estimate area

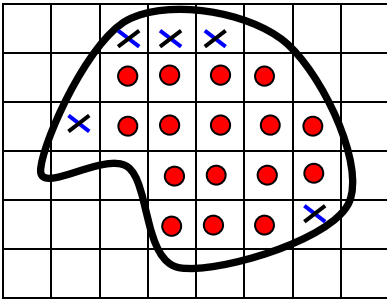

Number of whole squares (●) = 16
 Number of $\frac{1}{2}$ or more (X) = 5
Estimated area = 21 squares

• Shapes composed of rectangles

Put on all missing lengths first
 For perimeter - ADD all lengths round outside
 For area - split into rectangles & add them together

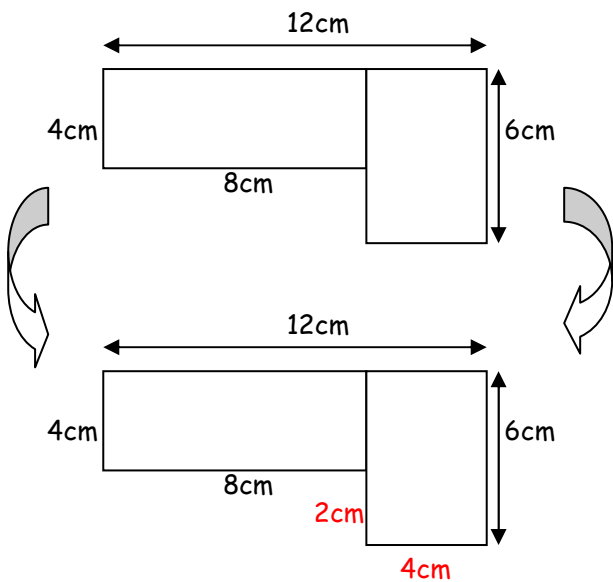

$$\text{Perimeter} = 12 + 6 + 4 + 2 + 8 + 4 = 36\text{cm}$$

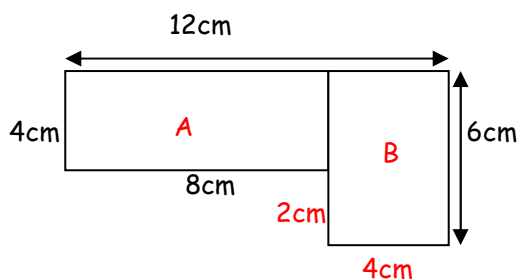

$$\begin{aligned} \text{Area of shape} &= \text{Area of A} + \text{B} \\ &= (8 \times 4) + (6 \times 4) \\ &= 32 + 24 \\ &= \underline{56\text{cm}^2} \end{aligned}$$

5/22 Volume

Volume is measured in cubes

The 1 cm cube

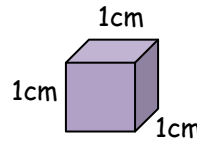

The volume of this cube is 1 cm^3
 (1 cubic centimetre)
It holds 1ml of water

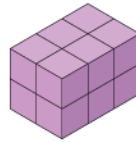

This cuboid contains 12 cubes
 So the volume is 12 cm^3

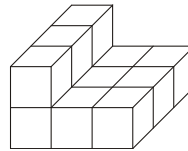

This 3D shape contains 12 cubes
 So the volume is 12 cm^3

5/23 Units of time

• Time conversion

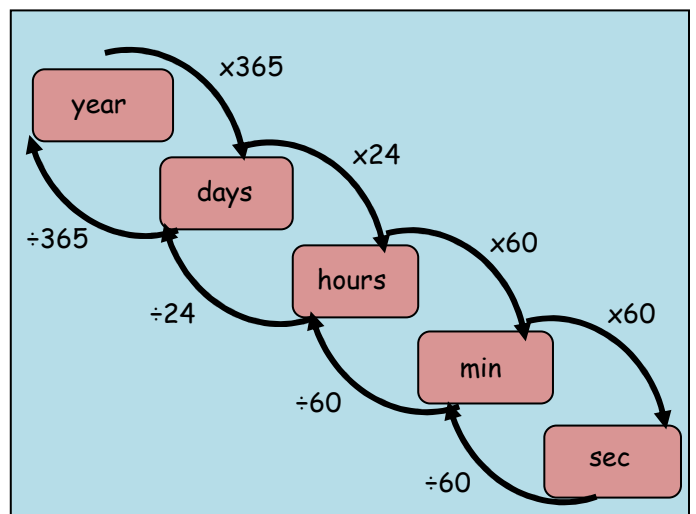

• Time intervals

Always go to the next whole hour first

Example: 0830 to 1125

$$30\text{min} + 2\text{h } 25\text{min} = 2\text{h } 55\text{min}$$

5/24 2D representations of 3D shapes

- There are 3 views:

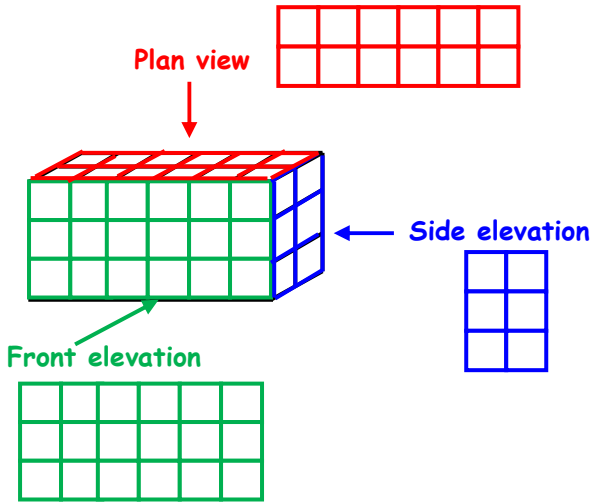

5/25 Angles

- Types of angles

Acute
(less than 90°)

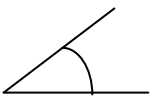

Obtuse
(Between 90° & 180°)

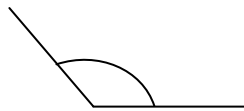

Reflex
(Between 180° & 360°)

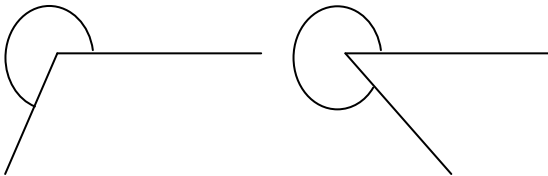

- Measure and draw angles

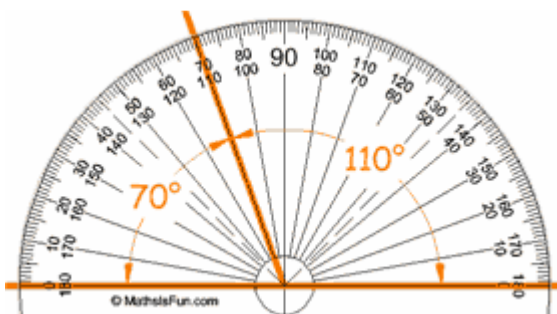

To be sure, count the number of degrees between the two arms of the angle

5/26 Angles

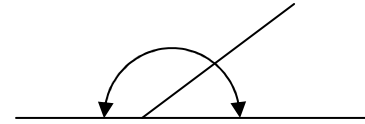

Angles on a straight line add up to 180°
or 2 right angles ($2 \times 90^\circ$)

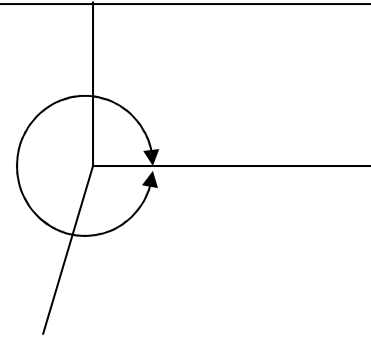

Angles about a point add up to 360°
or 4 right angles ($4 \times 90^\circ$)

5/27 Properties of the rectangle

- A rectangle is a quadrilateral (4 sided shape)
- All angles are 90°

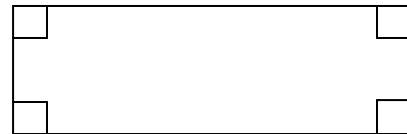

- Opposite sides are equal

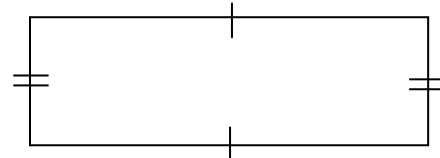

- Opposite sides are parallel

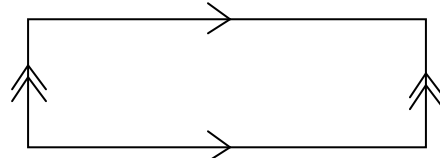

- Diagonals are equal

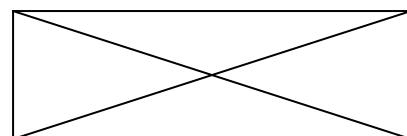

- Diagonals bisect each other (cut in half)

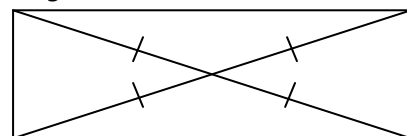

- A square is a special rectangle

5/28 Reflection

- Reflection in a vertical line

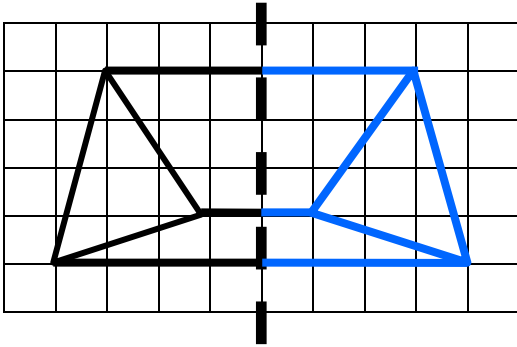

- Reflection in a horizontal line

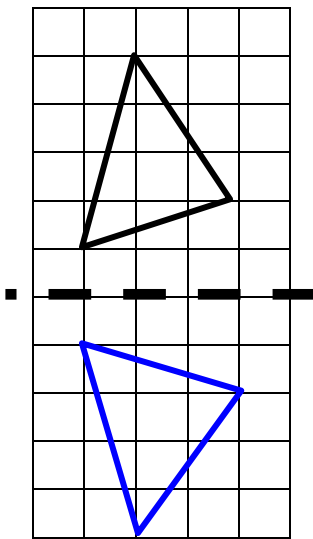

5/28 Translation - 4 right & 1 down

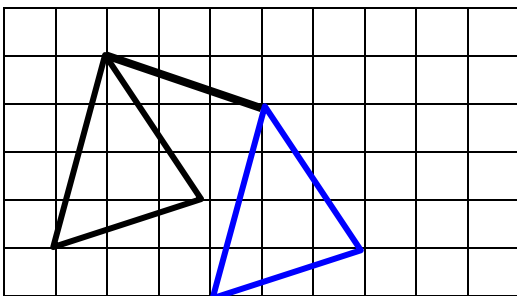

- In reflection and translation the shapes remain the same size and shape - CONGRUENT
- In reflection the shape is flipped over
- In translation the shape stays the same way up

5/29 Line graphs

- Find the difference

Example 1: What was the difference in temperature between 1030 and 1130?

Answer: $11.5^{\circ}\text{C} - 10^{\circ}\text{C} = 1.5^{\circ}\text{C}$

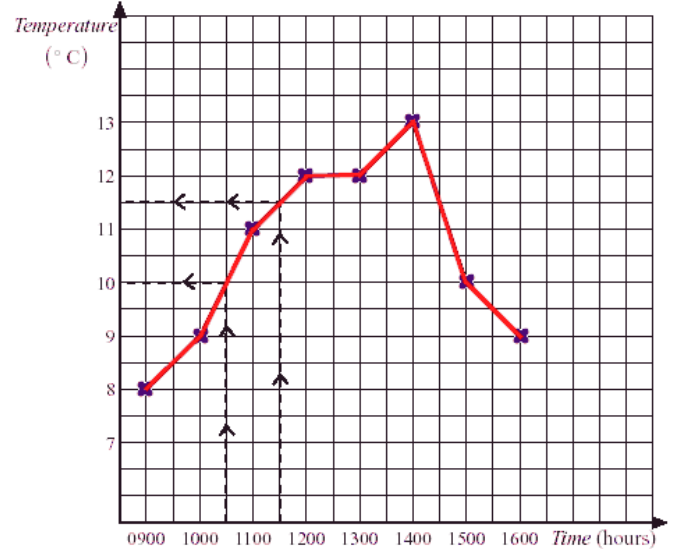

- Find the sum of the data

Example: What was the total number of days absent over the 6 years?

Answer: $3 + 4 + 7 + 7 + 9 + 2 = 32$ days

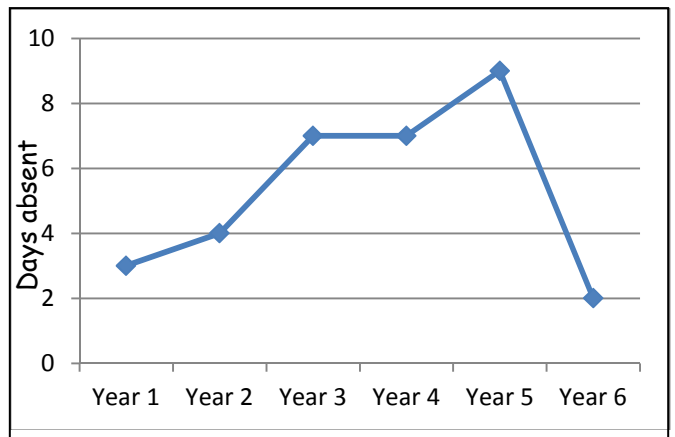

5/30 Interpret information in tables

- **Distance table**

Example: Find the distance between **Leeds** and **York**

Answer: 40miles

Hull				
100	Leeds			
162	73	Manchester		
110	60	65	Sheffield	
63	40	118	95	York

- **Timetable**

Example: How long is the film?

Answer: $1.10 - 2.35 = 1\text{h } 25\text{min} = 85\text{min}$

6.30am	Educational programme
7.00	Cartoons
7.25	News and weather
8.00	Wildlife programme
9.00	Children's programme
11.30	Music programme
12.30pm	Sports programme
1.00	News and weather
1.10 - 2.35pm	Film

- **Table of results of goals scored**

Example: Did boys or girls score the most goals?

Answer: Boys: $6+3+3+6=18$

Girls: $7+5=12$

Boys scored the most goals

	Game 1	Game 2	Game 3	Game 4	Game 5	Frequency
Peter	1	0	0	2	3	6
John	0	2	1	0	0	3
Ryan	1	0	1	1	0	3
Claire	2	0	2	1	2	7
Bill	3	1	1	0	1	6
Susan	0	1	3	1	0	5